

Applications

- High Frequency Isolated DC-DC Converters with Synchronous Rectification for Telecom and Industrial Use
- High Frequency Buck Converters for Computer Processor Power
- 100% R_G Tested
- Lead-Free

V _{DSS}	R _{DS(on)} max (mΩ)	I _D
30V	3.0@V _{GS} = 10V	260A [Ⓔ]

Benefits

- Ultra-Low Gate Impedance
- Very Low R_{DS(on)} at 4.5V V_{GS}
- Fully Characterized Avalanche Voltage and Current

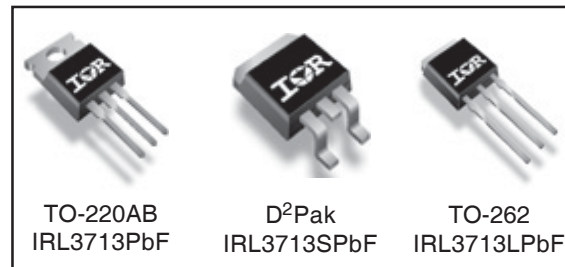

Absolute Maximum Ratings

Symbol	Parameter	Max	Units
V _{DS}	Drain-Source Voltage	30	V
V _{GS}	Gate-to-Source Voltage	± 20	V
I _D @ T _C = 25°C	Continuous Drain Current, V _{GS} @ 10V	260 [Ⓔ]	A
I _D @ T _C = 100°C	Continuous Drain Current, V _{GS} @ 10V	180 [Ⓔ]	
I _{DM}	Pulsed Drain Current [Ⓐ]	1040 [Ⓔ]	
P _D @ T _C = 25°C	Maximum Power Dissipation	330	W
P _D @ T _C = 100°C	Maximum Power Dissipation	170	
	Linear Derating Factor	2.2	W/°C
T _J , T _{STG}	Junction and Storage Temperature Range	-55 to +175	°C

Thermal Resistance

Symbol	Parameter	Typ	Max	Units
R _{θJC}	Junction-to-Case [Ⓒ]	—	0.45*	°C/W
R _{θCS}	Case-to-Sink, Flat, Greased Surface [Ⓓ]	0.50	—	
R _{θJA}	Junction-to-Ambient [Ⓔ] [Ⓒ]	—	62	
R _{θJA}	Junction-to-Ambient (PCB Mount) [Ⓔ] [Ⓒ]	—	40	

* R_{θJC} (end of life) for D²Pak and TO-262 = 0.50°C/W. This is the maximum measured value after 1000 temperature cycles from -55 to 150°C and is accounted for by the physical wearout of the die attach medium.

Notes [Ⓐ] through [Ⓒ] are on page 11

IRL3713/S/LPbF

International
IR Rectifier

Static @ $T_J = 25^\circ\text{C}$ (unless otherwise specified)

Symbol	Parameter	Min	Typ	Max	Units	Conditions
$V_{(BR)DSS}$	Drain-to-Source Breakdown Voltage	30	—	—	V	$V_{GS} = 0V, I_D = 250\mu A$
$\Delta V_{(BR)DSS}/\Delta T_J$	Breakdown Voltage Temp. Coefficient	—	0.027	—	V/°C	Reference to $25^\circ\text{C}, I_D = 1\text{mA}$
$R_{DS(on)}$	Static Drain-to-Source On-Resistance	—	2.6	3.0	mΩ	$V_{GS} = 10V, I_D = 38A$ ③
		—	3.3	4.0		$V_{GS} = 4.5V, I_D = 30A$ ③
$V_{GS(th)}$	Gate Threshold Voltage	1.0	—	2.5	V	$V_{DS} = V_{GS}, I_D = 250\mu A$
I_{DSS}	Drain-to-Source Leakage Current	—	—	50	μA	$V_{DS} = 30V, V_{GS} = 0V$
		—	—	20		$V_{DS} = 24V, V_{GS} = 0V$
		—	—	100		$V_{DS} = 24V, V_{GS} = 0V, T_J = 125^\circ\text{C}$
I_{GSS}	Gate-to-Source Forward Leakage	—	—	200	nA	$V_{GS} = 20V$
	Gate-to-Source Reverse Leakage	—	—	-200		$V_{GS} = -20V$

Dynamic @ $T_J = 25^\circ\text{C}$ (unless otherwise specified)

Symbol	Parameter	Min	Typ	Max	Units	Conditions
g_{fs}	Forward Transconductance	76	—	—	S	$V_{DS} = 15V, I_D = 30A$
Q_g	Total Gate Charge	—	75	110	nC	$I_D = 30A$
Q_{gs}	Gate-to-Source Charge	—	24	—		$V_{DS} = 15V$
Q_{gd}	Gate-to-Drain ("Miller") Charge	—	37	—		$V_{GS} = 4.5V$ ④
Q_{oss}	Output Gate Charge	—	61	92		$V_{GS} = 0V, V_{DS} = 15V$
R_G	Gate Resistance	0.5	—	3.4	Ω	
$t_{d(on)}$	Turn-On Delay Time	—	16	—	ns	$V_{DD} = 15V$
t_r	Rise Time	—	160	—		$I_D = 30A$
$t_{d(off)}$	Turn-Off Delay Time	—	40	—		$R_G = 1.8\Omega$
t_f	Fall Time	—	57	—		$V_{GS} = 4.5V$ ④
C_{iss}	Input Capacitance	—	5890	—	pF	$V_{GS} = 0V$
C_{oss}	Output Capacitance	—	3130	—		$V_{DS} = 15V$
C_{rss}	Reverse Transfer Capacitance	—	630	—		$f = 1.0\text{MHz}$

Avalanche Characteristics

Symbol	Parameter	Typ	Max	Units
E_{AS}	Single Pulse Avalanche Energy ②	—	1530	mJ
I_{AR}	Avalanche Current ①	—	46	A

Diode Characteristics

Symbol	Parameter	Min	Typ	Max	Units	Conditions
I_S	Continuous Source Current (Body Diode)	—	—	260 ⑥	A	MOSFET symbol showing the integral reverse p-n junction diode.
I_{SM}	Pulsed Source Current (Body Diode) ①⑥	—	—	1040 ⑥		
V_{SD}	Diode Forward Voltage	—	0.80	1.3	V	$T_J = 25^\circ\text{C}, I_S = 30A, V_{GS} = 0V$ ③
		—	0.68	—		$T_J = 125^\circ\text{C}, I_S = 30A, V_{GS} = 0V$ ③
t_{rr}	Reverse Recovery Time	—	75	110	ns	$T_J = 25^\circ\text{C}, I_F = 30A, V_R = 0V$
Q_{rr}	Reverse Recovery Charge	—	140	210	nC	$di/dt = 100A/\mu s$ ③
t_{rr}	Reverse Recovery Time	—	78	120	ns	$T_J = 125^\circ\text{C}, I_F = 30A, V_R = 20V$
		—	160	240		$di/dt = 100A/\mu s$ ③

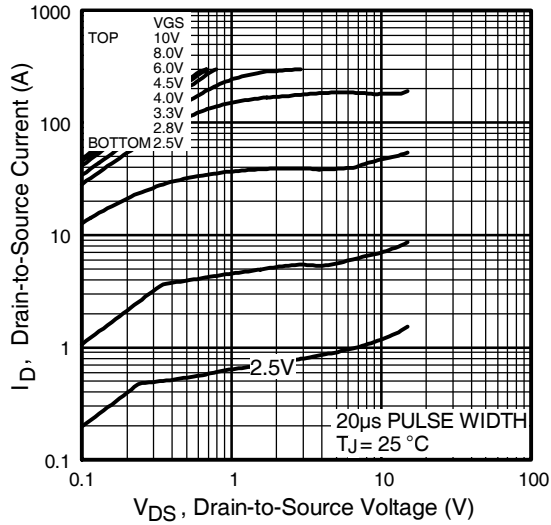

Fig 1. Typical Output Characteristics

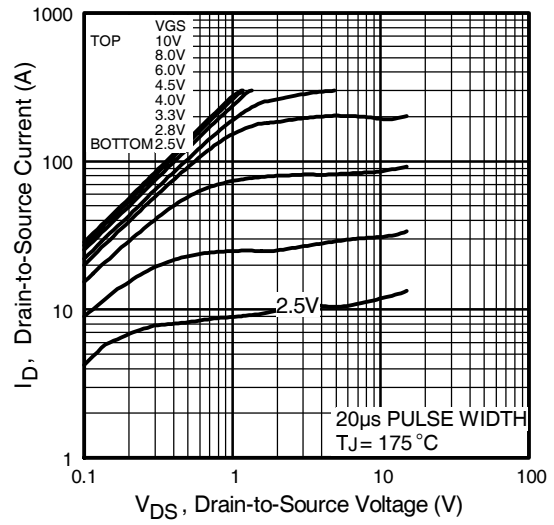

Fig 2. Typical Output Characteristics

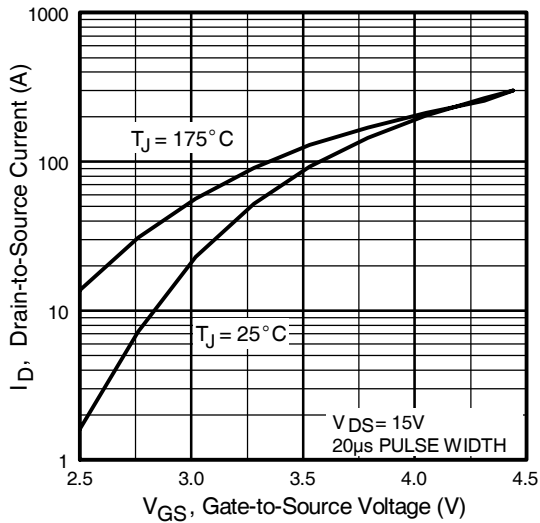

Fig 3. Typical Transfer Characteristics

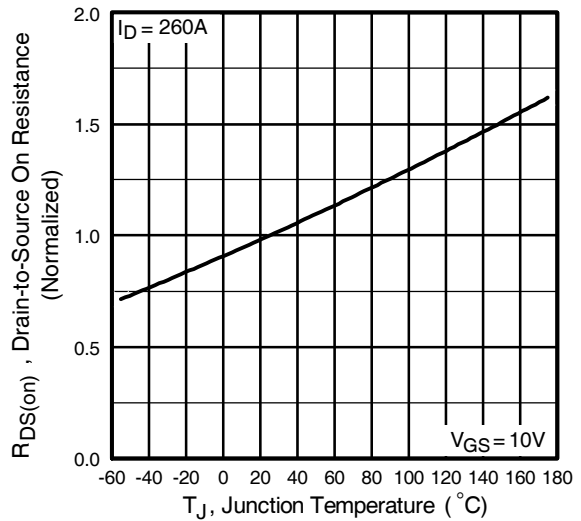

Fig 4. Normalized On-Resistance Vs. Temperature

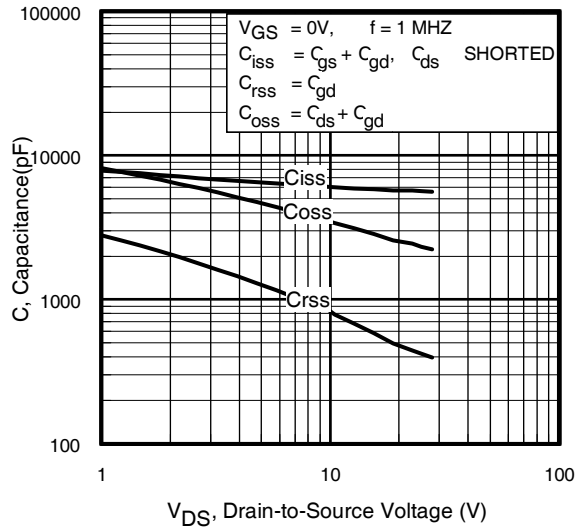

Fig 5. Typical Capacitance Vs. Drain-to-Source Voltage

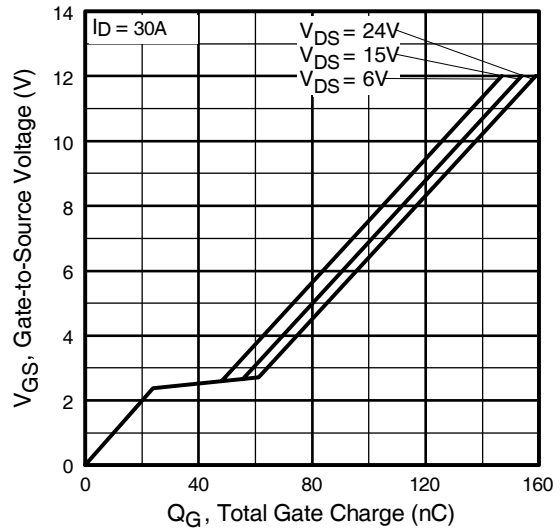

Fig 6. Typical Gate Charge Vs. Gate-to-Source Voltage

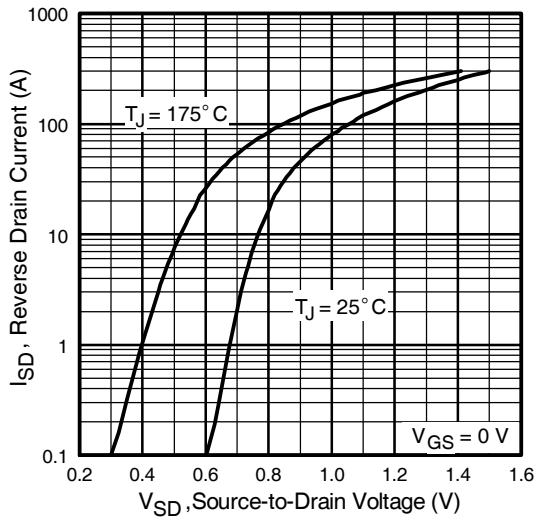

Fig 7. Typical Source-Drain Diode Forward Voltage

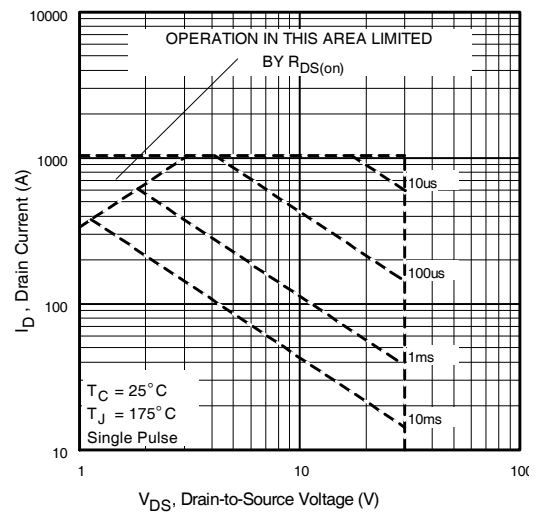

Fig 8. Maximum Safe Operating Area

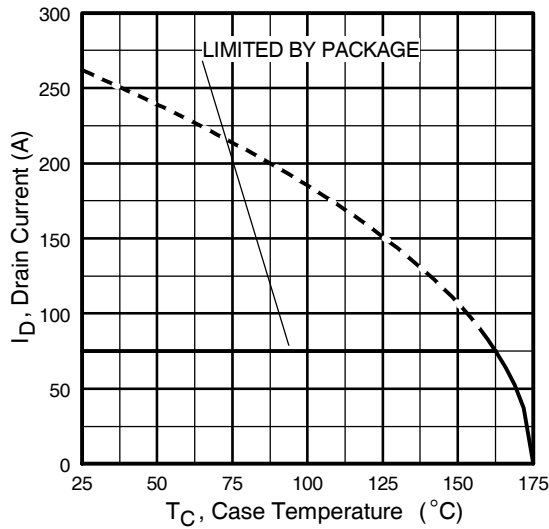

Fig 9. Maximum Drain Current Vs. Case Temperature



Fig 10a. Switching Time Test Circuit



Fig 10b. Switching Time Waveforms

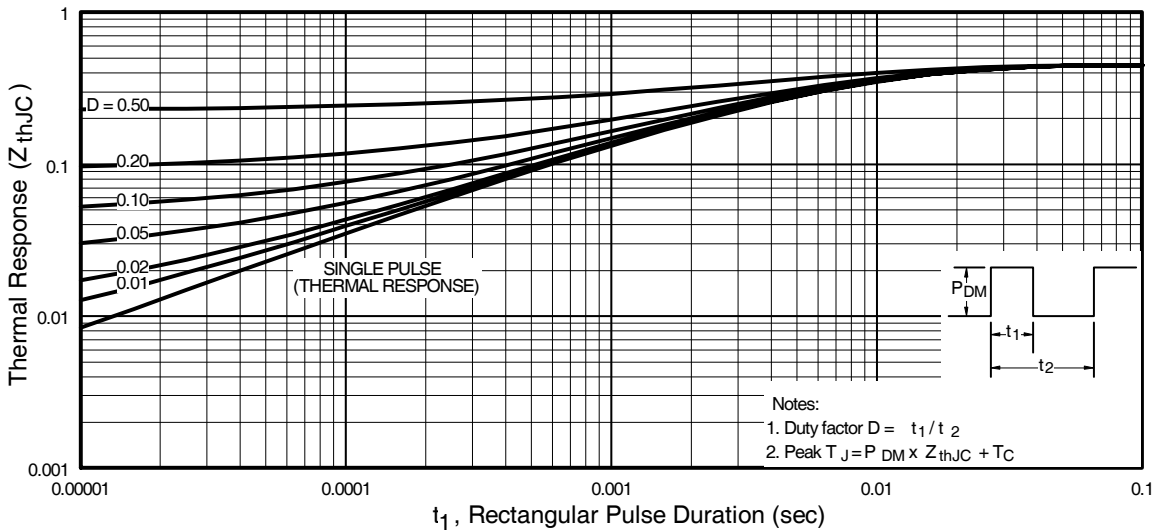

Fig 11. Maximum Effective Transient Thermal Impedance, Junction-to-Case

IRL3713/S/LPbF

International
IR Rectifier

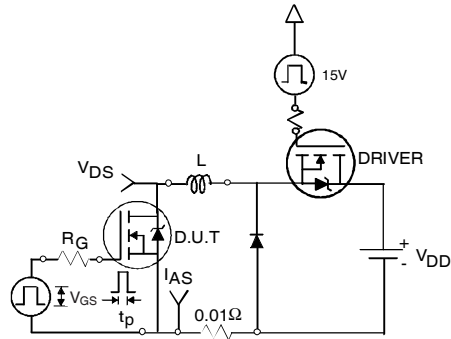

Fig 12a. Unclamped Inductive Test Circuit

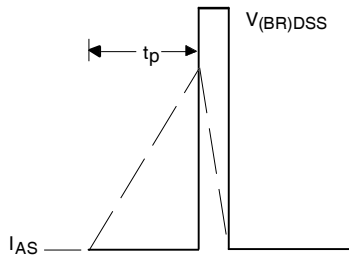

Fig 12b. Unclamped Inductive Waveforms

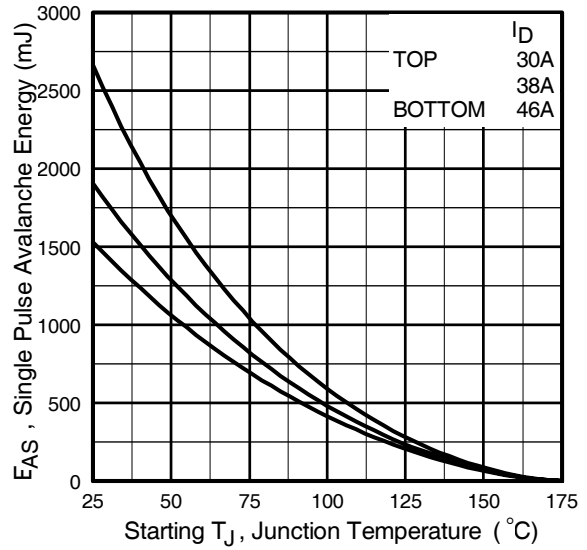

Fig 12c. Maximum Avalanche Energy Vs. Drain Current



Fig 13a. Basic Gate Charge Waveform

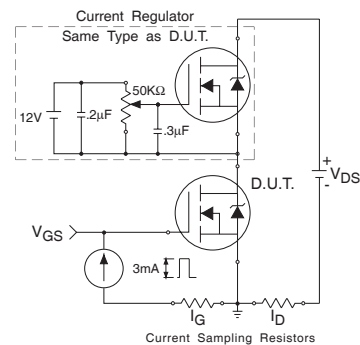
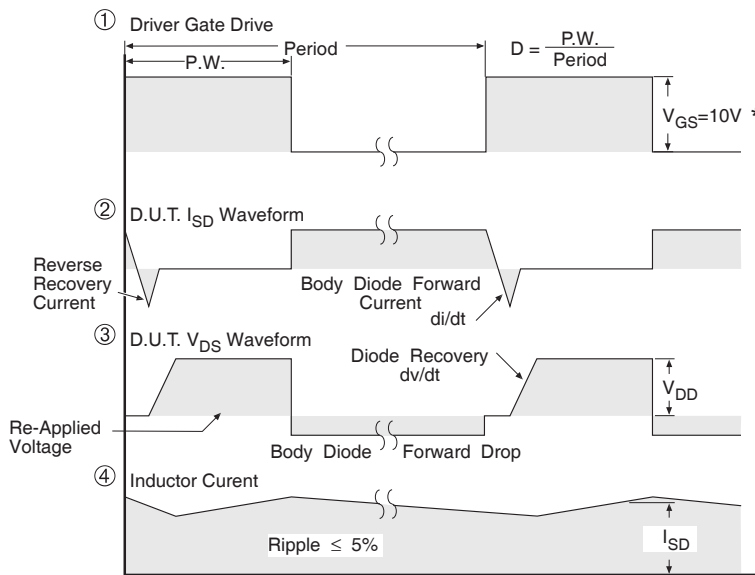

Fig 13b. Gate Charge Test Circuit

Peak Diode Recovery dv/dt Test Circuit



* $V_{GS} = 5V$ for Logic Level Devices

Fig 14. For N-Channel HEXFET® Power MOSFETs

IRL3713/S/LPbF

TO-220AB Package Outline

Dimensions are shown in millimeters (inches)

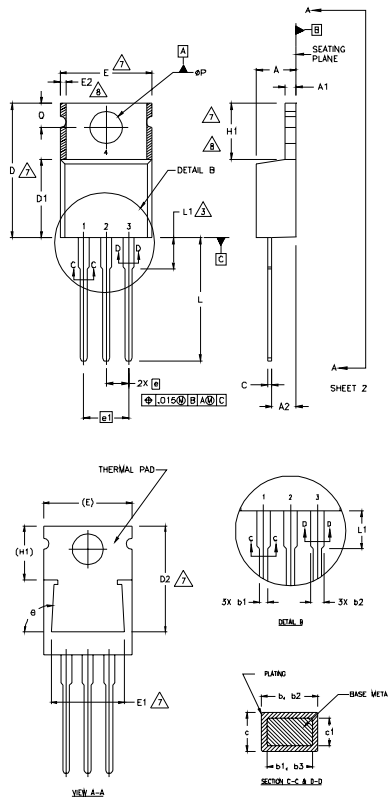

- NOTES:
- 1 DIMENSIONING AND TOLERANCING PER ASME Y14.5 M- 1994.
 - 2 DIMENSIONS ARE SHOWN IN INCHES [MILLIMETERS].
 - 3 LEAD DIMENSION AND FINISH UNCONTROLLED IN L1.
 - 4 DIMENSION D & E DO NOT INCLUDE MOLD FLASH. MOLD FLASH SHALL NOT EXCEED .005" (0.127) PER SIDE. THESE DIMENSIONS ARE MEASURED AT THE OUTERMOST EXTREMES OF THE PLASTIC BODY. DIMENSION b1 & c1 APPLY TO BASE METAL ONLY.
 - 5 CONTROLLING DIMENSION : INCHES.
 - 6 THERMAL PAD CONTOUR OPTIONAL WITHIN DIMENSIONS E,H1,D2 & E1
 - 7 DIMENSION E2 x H1 DEFINE A ZONE WHERE STAMPING AND SINGULATION IRREGULARITIES ARE ALLOWED.
 - 8

LEAD ASSIGNMENTS

HEXLEF

- 1 - GATE
- 2 - DRAIN
- 3 - SOURCE

IRBLS CoPACK

- 1 - GATE
- 2 - COLLECTOR
- 3 - EMITTER

DIODES

- 1 - ANODE/OPEN
- 2 - CATHODE
- 3 - ANODE

SYMBOL	DIMENSIONS				NOTES
	MILLIMETERS		INCHES		
	MIN.	MAX.	MIN.	MAX.	
A	3.56	4.82	.140	.190	
A1	0.51	1.40	.020	.055	
A2	2.04	2.92	.080	.115	
b	0.38	1.01	.015	.040	
b1	0.38	0.96	.015	.038	5
b2	1.15	1.77	.045	.070	
b3	1.15	1.73	.045	.068	
c	0.36	0.61	.014	.024	
c1	0.36	0.56	.014	.022	5
D	14.22	16.51	.560	.650	4
D1	8.38	9.02	.330	.355	
D2	12.19	12.88	.480	.507	7
E	9.66	10.66	.380	.420	4,7
E1	8.38	8.89	.330	.350	7
e	2.54 BSC		.100 BSC		
e1	3.08		.200 BSC		
H1	5.85	6.55	.230	.270	7,8
L	12.70	14.73	.500	.580	
L1	-	6.35	-	.250	3
øP	3.54	4.08	.139	.161	
Q	2.54	3.42	.100	.135	
ø	90°-93°		90°-93°		

TO-220AB Part Marking Information

EXAMPLE: THIS IS AN IRF1010
LOT CODE 1789
ASSEMBLED ON WW 19, 1997
IN THE ASSEMBLY LINE "C"

Note: "P" in assembly line position indicates "Lead-Free"

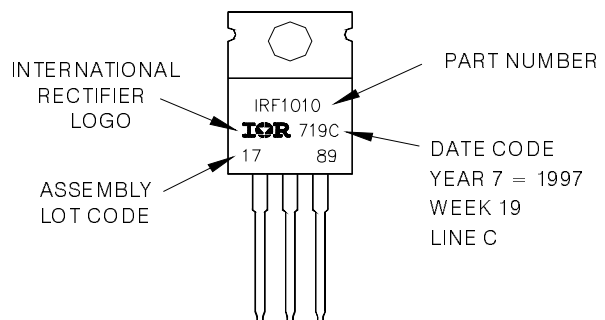

D²Pak Package Outline

Dimensions are shown in millimeters (inches)

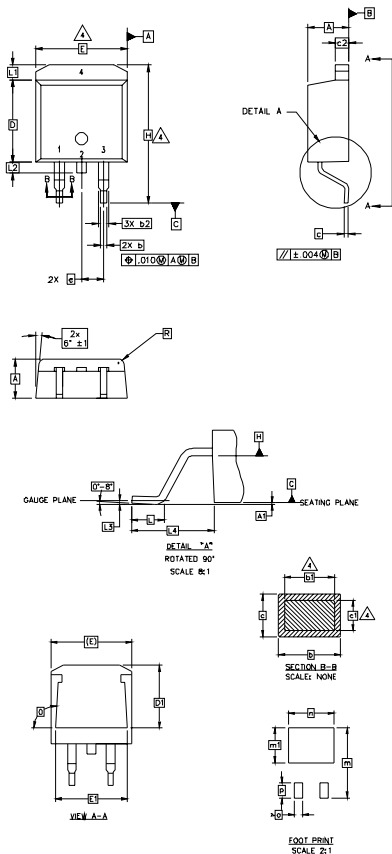

NOTES:

1. DIMENSIONING AND TOLERANCING PER ASME Y14.5M-1994
2. DIMENSIONS ARE SHOWN IN MILLIMETERS [INCHES].
3. DIMENSION D & E DO NOT INCLUDE MOLD FLASH. MOLD FLASH SHALL NOT EXCEED 0.127 [.005"] PER SIDE. THESE DIMENSIONS ARE MEASURED AT THE OUTMOST EXTREMES OF THE PLASTIC BODY.
4. DIMENSION b1 AND c1 APPLY TO BASE METAL ONLY.
5. CONTROLLING DIMENSION: INCH.

SYMBOL	DIMENSIONS				NOTES
	MILLIMETERS		INCHES		
	MIN.	MAX.	MIN.	MAX.	
A	4.06	4.83	.160	.190	
A1	0.00	0.254	.000	.010	
b	0.51	0.99	.020	.039	4
b1	0.51	0.89	.020	.035	
b2	1.14	1.78	.045	.070	
c	0.38	0.74	.015	.029	
c1	0.38	0.58	.015	.023	4
c2	1.14	1.65	.045	.065	
D	8.51	9.65	.335	.380	3
D1	6.86		.270		
E	9.65	10.67	.380	.420	3
E1	6.22		.245		
e	2.54 BSC		.100 BSC		
H	14.61	15.88	.575	.625	
L	1.78	2.79	.070	.110	
L1		1.65		.065	
L2	1.27	1.78	.050	.070	
L3	0.25 BSC		.010 BSC		
L4	4.78	5.28	.188	.208	
m	17.78		.700		
m1	8.89		.350		
n	11.43		.450		
o	2.08		.082		
p	3.81		.150		
R	0.51	0.71	.020	.028	
θ	90°	93°	90°	93°	

LEAD ASSIGNMENTS

HEXFET

- 1.- GATE
- 2, 4.- DRAIN
- 3.- SOURCE

IGBTs, CoPACK

- 1.- GATE
- 2, 4.- COLLECTOR
- 3.- EMITTER

DIODES

- 1.- ANODE *
- 2, 4.- CATHODE
- 3.- ANODE

* PART DEPENDENT.

D²Pak Part Marking Information

EXAMPLE: THIS IS AN IRF530S WITH
LOT CODE 8024
ASSEMBLED ON WW 02, 2000
IN THE ASSEMBLY LINE 'L'

Note: "P" in assembly line position
indicates "Lead - Free"

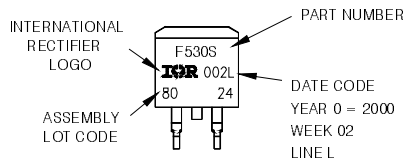

OR

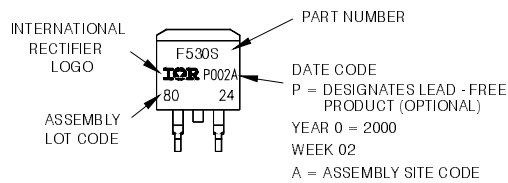

IRL3713/S/LPbF

TO-262 Package Outline

Dimensions are shown in millimeters (inches)

International
IR Rectifier

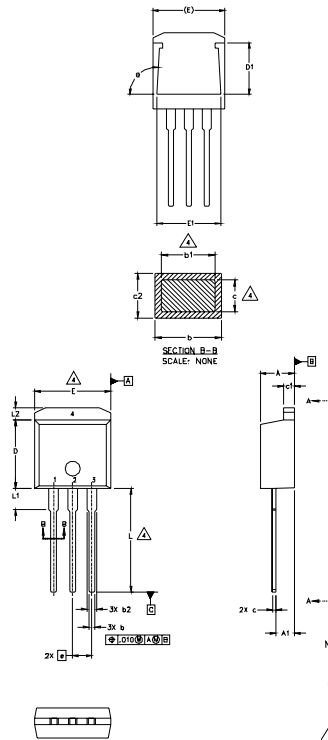

SYMBOL	DIMENSIONS				NOTES
	MILLIMETERS		INCHES		
	MIN.	MAX.	MIN.	MAX.	
A	4.06	4.83	.160	.190	
A1	2.03	2.92	.080	.115	
b	0.51	0.99	.020	.039	
b1	0.51	0.89	.020	.035	4
b2	1.14	1.40	.045	.055	
c	0.38	0.63	.015	.025	4
c1	1.14	1.40	.045	.055	
c2	0.43	.063	.017	.029	
D	8.51	9.65	.335	.380	3
D1	5.33		.210		
E	9.65	10.67	.380	.420	3
E1	6.22		.245		
e	2.54 BSC		.100 BSC		
L	13.46	14.09	.530	.555	
L1	3.56	3.71	.140	.146	
L2		1.65		.065	

LEAD ASSIGNMENTS

HEXFET

- 1.- GATE
- 2.- DRAIN
- 3.- SOURCE
- 4.- DRAIN

IGBT

- 1 - GATE
- 2 - COLLECTOR
- 3 - EMITTER

NOTES:

1. DIMENSIONING AND TOLERANCING PER ASME Y14.5M-1994
2. DIMENSIONS ARE SHOWN IN MILLIMETERS [INCHES]
3. DIMENSION D & E DO NOT INCLUDE MOLD FLASH. MOLD FLASH SHALL NOT EXCEED 0.127 [.005"] PER SIDE. THESE DIMENSIONS ARE MEASURED AT THE OUTMOST EXTREMES OF THE PLASTIC BODY.
4. DIMENSION b1 AND c1 APPLY TO BASE METAL ONLY.
5. CONTROLLING DIMENSION: INCH.

TO-262 Part Marking Information

EXAMPLE: THIS IS AN IRL3103L
LOT CODE 1789
ASSEMBLED ON WW 19, 1997
IN THE ASSEMBLY LINE 'C'

Note: 'P' in assembly line position indicates 'Lead-Free'

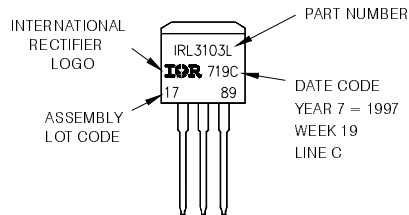

OR

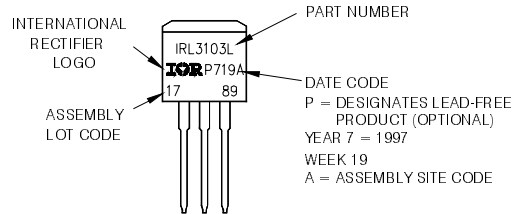

D²Pak Tape & Reel Information

Dimensions are shown in millimeters (inches)

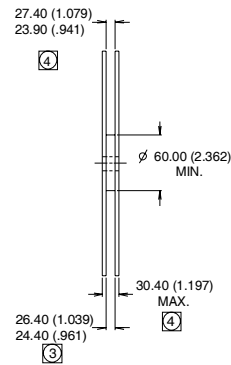
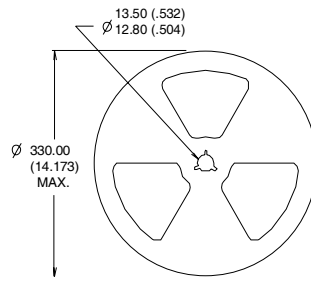
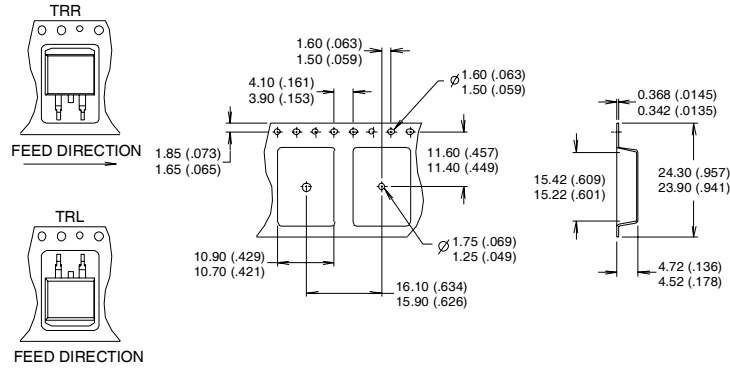

- NOTES:
1. COMFORMS TO EIA-418.
 2. CONTROLLING DIMENSION: MILLIMETER.
 3. DIMENSION MEASURED @ HUB.
 4. INCLUDES FLANGE DISTORTION @ OUTER EDGE.

Notes:

- ① Repetitive rating; pulse width limited by max. junction temperature.
- ② Starting $T_J = 25^\circ\text{C}$, $L = 1.4\text{mH}$, $R_G = 25\Omega$, $I_{AS} = 46\text{A}$, $V_{GS} = 10\text{V}$.
- ③ Pulse width $\leq 400\mu\text{s}$; duty cycle $\leq 2\%$.
- ④ This is only applied to TO-220A package.
- ⑤ This is applied to D²Pak, when mounted on 1" square PCB (FR-4 or G-10 Material). For recommended footprint and soldering techniques refer to application note #AN-994.
- ⑥ Calculated continuous current based on maximum allowable junction temperature. Package limitation current is 75A.
- ⑦ R_θ is measured at T_J approximately 90°C .

Data and specifications subject to change without notice.
 This product has been designed and qualified for the Industrial market.
 Qualification Standards can be found on IR's Web site.

International
IR Rectifier

IR WORLD HEADQUARTERS: 233 Kansas St., El Segundo, California 90245, USA Tel: (310) 252-7105
 TAC Fax: (310) 252-7903

Visit us at www.irf.com for sales contact information. 07/05

Note: For the most current drawings please refer to the IR website at:
<http://www.irf.com/package/>